



Horizon

User Manual



Supporting
Children



The Leckey Horizon has been designed to offer the option of Supine and Prone Standing in one whilst providing an unrivalled level of positional support. This manual shows you how you can quickly and easily make use of all of the functions. The instructions on the safety and maintenance of the product will ensure that you will enjoy the use of this product for a long time.

CONTENTS

01	Intended use
02	Declaration of Conformity
03	Warnings and Cautions
04	Terms of warranty
05	Product history record
06	Product training record
07	Safety information
08	Precautions and Contraindications
09	How to unpack and assemble
10	Clinical setup for postural management
11	Product conversion
12	Frequent adjustments for daily use
13	Cleaning & care information
14	Daily product inspection
15	Reissuing Leckey products
16	Technical Data
17	Specifications for LINAK

SECTION 01: INTENDED USE

Intended use

The devices are intended to assist children that cannot stand or maintain a standing position independently as part of a supported weight bearing program.

Indications for use

Horizon is for use in prone and supine standing but may also be used for upright standing. Horizon is intended for adults and children (aged 4 years+). The maximum user weight limit on the size one Horizon is 50kg (110lbs), size two is 80kg (176lbs) and size three 100kg (220lbs). Suitable for:

- Children and adults with disabilities such as Cerebral Palsy, traumatic brain injuries, muscular dystrophy and other conditions where supported standing programs are encouraged.
- More complex children or adults who have not benefitted from standing therapy for some time.

SECTION 02: DECLARATION OF CONFORMITY

The Horizon is classified as a Class I Medical Device under EU and UK regulations. James Leckey Design Ltd as manufacturer with sole responsibility declares that the Leckey Horizon conforms to the requirements of the 93/42/EEC Guidelines, Medical Device Regulations 2017, UK Medical Devices Regulation 2002 and EN 12182 Technical aids for disabled persons and test methods.

Notice to the user and/or patient: Any serious incident that has occurred in relation to the device should be reported to the manufacturer and the competent authority of the Member



NOTE:

General user advice

Not following these instructions may result in physical injury, damage to the product or damage to the environment!

SECTION 03: WARNINGS AND CAUTIONS

1) WARNING TOPPLING HAZARD

- Never use the product on a sloping surface greater than 5 degrees.
- Always check operation of linear drives, gas struts, and motor drives before use.
- When adjusting the stander angle ensure there is adequate access space on all sides of the product.
- Always lock casters facing outwards before placing the user in the product.

2) WARNING FINGER TRAP HAZARD

- Ensure that the user or carer does not touch any moving joint or pivot that is not locked.
- While the user is in the product, the carer should strive to keep product adjustments to a minimum.

3) WARNING OCCUPANT SECURITY

- User transfers in and out of the product must be done with appropriate equipment and personnel.
- When transferring the user into the product, first use the pelvic band to secure the user.
- Ensure that all harnesses, sandal straps and chest pad are securely applied.
- If the user exhibits any form of distress, remove from the product as quickly as is safely possible.

4) CAUTION FINGER PINCH HAZARD

- While the user is in the product, the carer should strive to keep product

adjustments to a minimum.

- Take care when assembling or adjusting the position of the stander components that your fingers do not get pinched when positioning stander components and tightening mountings.
- During product assembly and adjustment, the carer should avoid finger pinching risk of the product's joints or pivots.
- During transfers and adjustments, the carer should avoid the finger pinching risk of over-centre buckles and latches.

5) CAUTION DAILY CHECKS

- The stander is to be checked daily before use to ensure that all harnesses and stander components are securely attached.
- Always check operation of linear drives, gas struts, and motor drives before use.

6) CAUTION TRIP HAZARD WITH POWERED CHASSIS

- Before moving a powered stander ensure that battery charging connection is removed.

7) CAUTION CLEANING

- Clean the stander regularly to prevent the build-up of dirt. Accumulated dirt can prematurely wear the fabric components and encourage corrosion on the stander. Only use non-abrasive household cleaners and moist cloths, do not use running water on the

upholstery whilst it is still attached to the seat. See section Cleaning & care information.

8) CAUTION CLEANING POWER WASHERS/HOSES

- Hoses and power washers are not to be used to clean the product. Standers with the electric lift system are not sealed against running water and may be damaged by water ingress. See section Cleaning & care information.

9) CAUTION SERVICING/REPAIR OF ELECTRONIC COMPONENTS

- All electronic and electrical components are NOT user-serviceable. Servicing and repairs are only to be carried out by Leckey-authorized personnel.

10) CAUTION DISPOSAL

- When disposing of the product using a community waste disposal site, the frame and any electrical components should be disposed of separately.

11) CAUTION BRINGING INTO USE

- Before use, allow 2 hours for the product to acclimatise to room temperature.

State in which the user and/or patient is established.

SECTION 04: TERMS OF WARRANTY

The Warranty applies only when the product is used according to the specified conditions and for the intended purposes, following all manufacturer's recommendations (also see general terms of sales, delivery and payment). A three year warranty (1 year for electrical) is provided on all Leckey

manufactured products and components.

SECTION 05:

PRODUCT HISTORY RECORD

Your Leckey product is classified as a Class 1 Medical device and as such should only be prescribed, set up or reissued for use by a technically competent person who has been trained in the use of this product. Leckey recommend that a written record is

maintained to provide details of all setups, reissue inspections and annual inspections of this product.

SECTION 06:

PRODUCT TRAINING RECORD

(PARENTS, TEACHERS & CARERS)

Your Leckey product is a prescribed Class 1 Medical Device and as such Leckey recommend that parents, teachers and carers using the equipment should be

SECTION 7

Safety Information

SECTION 12

Frequent Adjustments for Daily Use

SECTION 13

Cleaning and Care Information

SECTION 14

Daily Product Inspection

made aware of the following sections of this user manual by a technically competent person:

Leckey recommend that a written record is maintained of all those who have been trained in the correct use of this product.

SECTION 07: SAFETY INFORMATION

1. Always read instructions fully before use.
2. Users should not be left unattended at any time whilst using Leckey equipment.
3. Only use Leckey approved components with your product. Never modify the product in any way. Failure to follow instructions may put the user or carer at risk and will invalidate the warranty on the product.
4. If in any doubt to the continued safe use of your product or if any parts should fail, please cease using the product and contact our customer services department or local dealer as soon as possible.
5. Carry out all positional adjustments and ensure that they are securely fastened before you put the user into this product. Some adjustments may require the use of a tool which is provided with each product. Keep all tools out of reach of children.
6. When placing the user into the standing frame, for safety reasons, always secure the user's feet and the chest straps first. Then the hip and knee straps should be fastened.
7. When used in the supine position it is important to ensure the knee pad is

- fastened securely. Always check the clips are fully engaged.
8. Although the stander is fitted with castors it is not a mobility device. Always ensure that the castor brakes be locked at all times when the frame is in use, being adjusted or even just stored.
 9. When adjusting the angle of the Stander ensure that the user and all parts of the product are well clear of surrounding furnishings to avoid potential collisions.
 10. It is not recommended to adjust the height of the back pad whilst the frame is in use and in vertical position. Other fine positional adjustments may be carried out safely when the user is in the frame. It is important to support all pads when adjusting them while the user is in the product.
 11. Never leave the product on a sloping surface, greater than 5 degrees. Always remember to lock all the castors.
 12. The product contains components which could present a choking hazard to small children. Always check that locking knobs and bolts within the child's reach are tightened and secure at all times.
 13. Leckey products comply with fire safety regulations in accordance with EN12182. However the product contains plastic components and therefore should be kept away from all direct sources of heat including naked flames, cigarettes, electric and gas heaters.
 14. Never place hot items on the Activity Tray as they may damage the plastic.
 15. Clean the product regularly. Do not use abrasive cleaners. Carry out maintenance checks on a regular basis to ensure your product is in good working condition.
 16. The product is designed for indoor use and when not in use should be stored in a dry place that is not subjected to extremes of temperature. The safe operating temperature range of the product is +5 to +40 deg Celsius.
 17. The product has a battery power source. It complies with the requirements of BS EN 60601 Medical electrical equipment – general requirements for safety. Please read and adhere to the guidelines on charging the battery detailed in section 9.

SECTION 08: PRECAUTIONS AND CONTRAINDICATIONS

Precautions

- Fixed spinal deformities such as scoliosis or kyphosis
- Severe muscle contractures
- Severe muscular or skeletal asymmetry including hip dislocation
- Progressive and muscle wasting conditions
- High risk or recent history of bone fractures
- High risk of pressure related injury or open sores
- Strong, uncontrolled movement patterns
- Poorly controlled seizure activity
- Children dependent on the use of percutaneous endoscopic gastrostomy
- Medical instability including compromised respiratory or cardiovascular function
- Dependant on 3rd party life-sustaining apparatus such as oxygen tanks
- Significant learning disabilities and/or behavioural issues

Contraindications

- Children experiencing pain or discomfort that cannot be resolved by adjustment of support/positioning
- Children with hip/ knee flexion contracture beyond the limits of the stander

All precautions and contraindications are taken at the discretion of the prescribing clinician or parent. Leckey recommends a trained and experienced clinician to be present during all initial assessment, set ups, configurations, and reissues to minimise risk.

SECTION 09: HOW TO UNPACK AND ASSEMBLE

Congratulations on purchasing your Leckey Horizon. Your Leckey Horizon will be boxed on a pallet. You should first cut the straps and remove the outer lid and cardboard sleeve. The tray will be packaged separately and should be removed from the box before trying to move the stander. You can then remove the remaining packaging, unlock the castors and roll the stander off the pallet. Please check that you have all the parts you have ordered. The castors should then be locked into position, facing out from the frame at 45 degrees.

Some of the components will be wrapped in polythene packaging.



Safety first
Keep polythene bags away
from children.

Multi-tool

A number of adjustments will require the use of the multi-tool, which is supplied with each product.

Charging the battery

Before the product is used for the first time it is recommended to charge the battery fully for at least 12 hours. To charge the battery **A**, plug the adaptor into the mains socket, attach the lead to the frame and switch on the mains

power. While charging, the charger LED will remain orange and will turn to green when fully charged. When charged switch off mains power, remove the adaptor plug and disconnect the lead from the frame. The battery charge should be topped up each day for approximately one hour.



If the battery is low in power an audible beep will sound indicating that it needs to be charged. 'Battery low' will also be indicated on both handset and control box **B**.

Setting the Angle

Whether used in supine or prone the frame angle can be easily adjusted with the push button control handset or the control box. Use angle indicator on frame for guidance.

Ensure that the product and user are away from surrounding furnishings to prevent possible collisions when adjusting the angle.



Safety first
Keep polythene bags away from children.

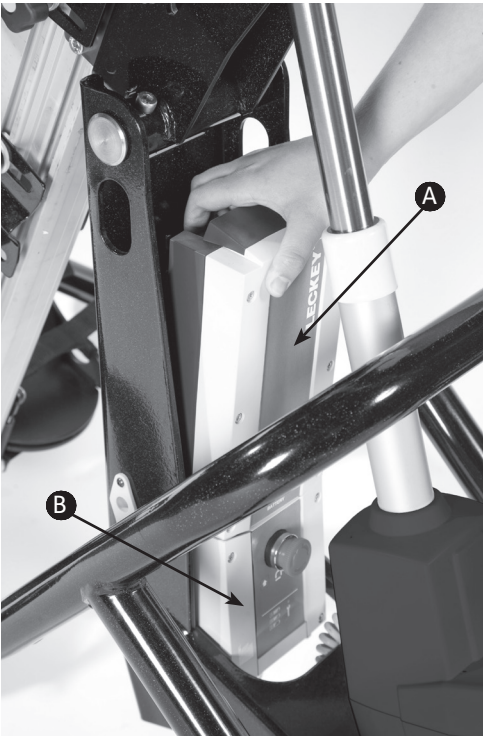

9.1 HOW TO ATTACH THE TRAY IN PRONE STANDING

The tray is attached to and removed from the frame by sliding the square metal tube into the top of the main spine. Before you insert the tube unlock the locking lever **A**, insert the tube and relock the lever.

To lock the tray and set its height push the locking lever **A** down until it touches the metal spine. After use the locking lever needs to be fine tuned to ensure secure locking. To do this lift up the lever and turn the nut **B** while holding the lever in a fixed position. Push the lever back down to check if it locks the tube securely. Repeat the process as necessary.

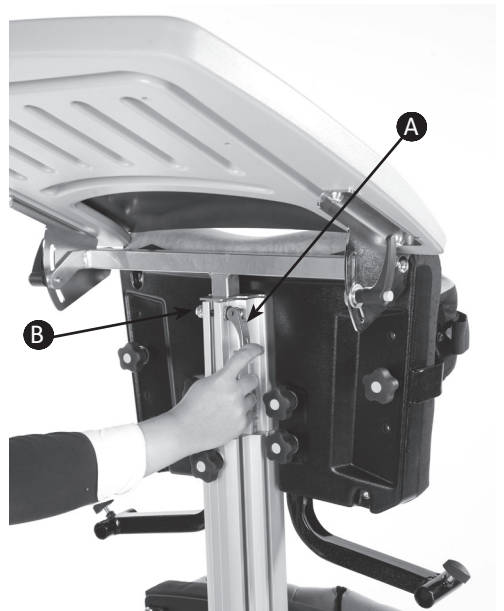



Always use caution when making this adjustment, as fingers could become trapped in the receiving tube while positioning.

9.2 HOW TO ATTACH THE TRAY IN SUPINE STANDING

The Tray is attached to and removed from the frame by the metal brackets located below the chest pad. To attach the tray slide the metal bars into the receiving tubes to the required depth and secure by tightening the knobs **A** on either side.



9.3 INSERTING ATTACHMENT BOLT INTO THE SANDALS

Insert the required attachment bolt **A** along with the retention plate **B**. Place a rubber lid **C**, on both, the top and

bottom of the sandal. Fasten using the four screws **D**, provided. To remove or replace the attachment bolt, reverse this process.

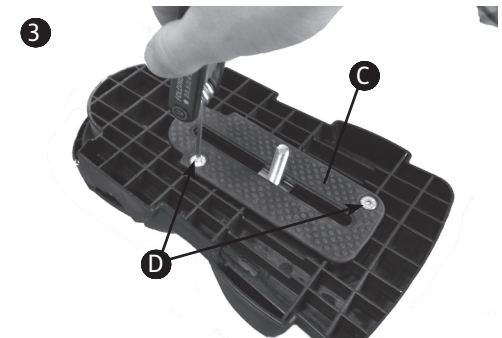
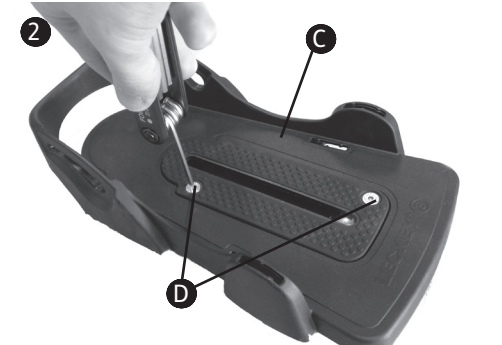
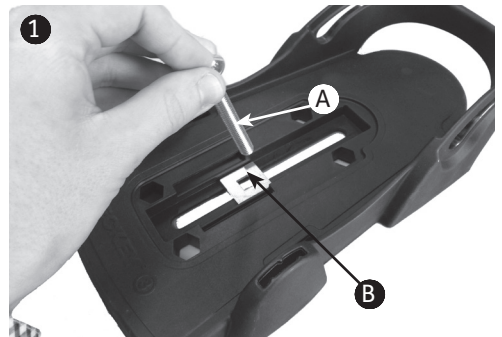

9.4 ATTACHING THE SANDALS

Place the sandal so that the attachment bolt goes through the slot in the footplate. To secure, on the underside of the footplate place the rubber washer **A** followed by the metal washer **B** and then the knob **C**, onto the attachment bolt. To position the sandals simply loosen the knob **C**, under the footplate, select the position you require and re-fasten the knob.

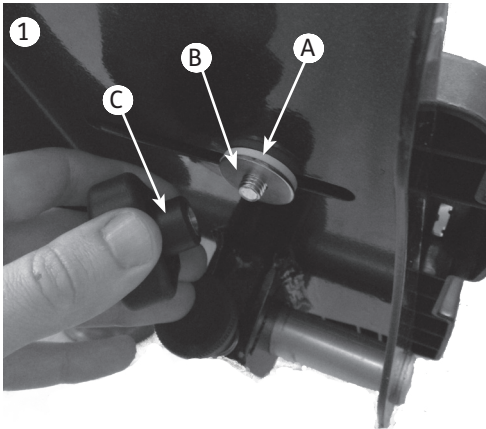

9.5 HOW TO ATTACH THE HEADSUPPORT & EXTENDED HEADREST BRACKET IN SUPINE

To attach and height adjust, slide the square tubing into the top of the central spine on the backrest. To lock the head support push the locking lever down until it touches the metal spine **B**. To remove simply reverse this process. The extended headrest, the contoured head support and the Whitmyer Pro-Series range of headsupports can also be attached to the frame as detailed above.

After use, the locking lever may need to be fine tuned to ensure secure locking. To do this lift up the lever and turn the nut **C** while holding the lever in a fixed position. Push the lever back down to check if it locks the tube securely. Repeat the process as necessary.

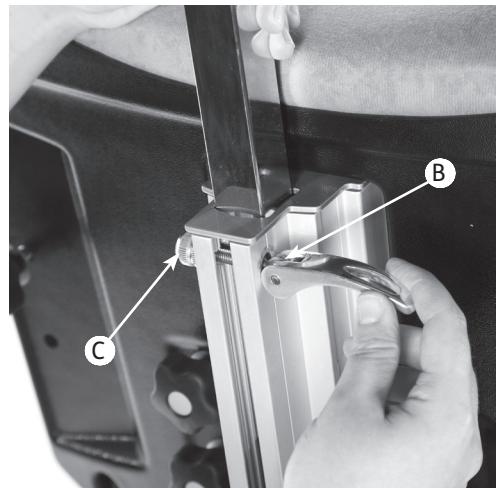



Always use caution when making this adjustment, as fingers could become trapped in the receiving tube while positioning.

9.6 HOW TO ATTACH THE HEAD SUPPORT IN PRONE

If head support is needed in prone standing the Leckey Interface Frame (LIF) can be used with Horizon. The LIF is attached to and removed from the frame by the metal brackets located below the chest pad. To attach, slide the metal bars into the receiving tubes to the required depth and secure by tightening the knobs on either side.

Please refer to the specific user manual on the Leckey Interface Frame to safely position the frame and its accessories.

This frame will also accommodate the Whitmyer pro-series range of head supports.

9.7 HOW TO ATTACH FLEXIBLE GUIDES

To attach the flexible guides, loosen the plastic knob **A** at the back of the pad and slide the metal bracket into the slot. Then when set to the desired height retighten the plastic knob. Repeat on the other side.

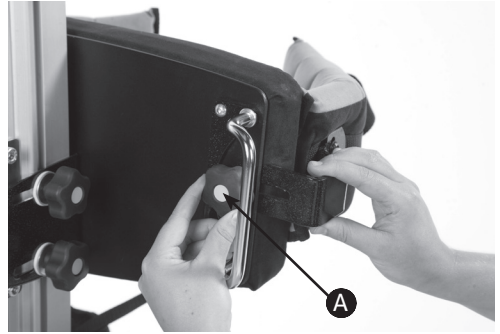

9.8 HOW TO ATTACH AND REMOVE BASIC / FLIP-AWAY / 3D FOOTPLATES

To remove the footplate loosen the bolts which attach the footplate to the bottom of the spine **A**. Slide the footplate downwards and remove.

To attach a footplate, loosen the bolts at either side of the footplate **A** and slide upwards on to spine. Ensure the slider plate is firmly inserted into groove in spine. Tighten the bolts once the footplate is in the required position.

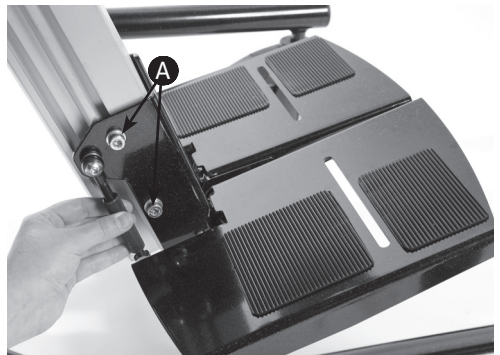

SECTION 10: CLINICAL SETUP FOR POSTURAL MANAGEMENT

The clinical setup of the product should be completed by a technically and clinically competent person who has been trained in the use of the product. Leckey recommend a written record is maintained of all clinical setups for this product.

10.1 ADJUSTING THE CHEST PAD

For prone standing, you should firstly measure the distance from the users feet to just under their arms and for supine you should measure to the top of the shoulder. This is best done were practical in a lying position on a mat. The height between the top of the chest pad or top and the sandals should be set to the equivalent of this distance.

To position the pad, loosen the knob at the back of the spine **A** and slide the pad to the required position and retighten securely. Always support the pad before loosening the knob to prevent the pad slipping unexpectedly.

The height of the chest pad should not be adjusted when the stander is in an upright position and in use. Maximum adjustment of the chest pad is 40 cm/16 inches, as displayed on the calibration strip at the side of the spine.



Never adjust the height of the chest pad when the user is in the product as the user's weight may collapse the height of the frame causing injury to the user or carer.

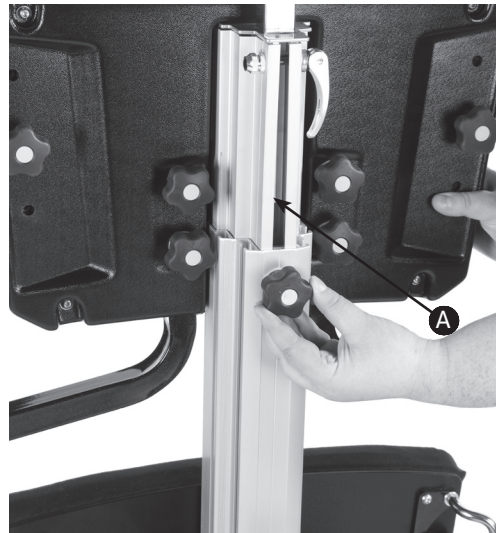

10.2 ADJUSTING THE HIP PAD

The hip pad can be height, depth and angle adjusted for optimum pelvic position. The height of the pad is set to the equivalent distance between the user's pelvis and their feet. To adjust the hip pad loosen the four knobs **A** on either side of the central spine at the back of the pad and slide the pad into the required position. Once the required position is obtained the knobs should be re-tightened securely.



Always check the pads are secure before placing the user in the product.



Always use caution when making this adjustment, as fingers could become trapped in the slot while positioning.

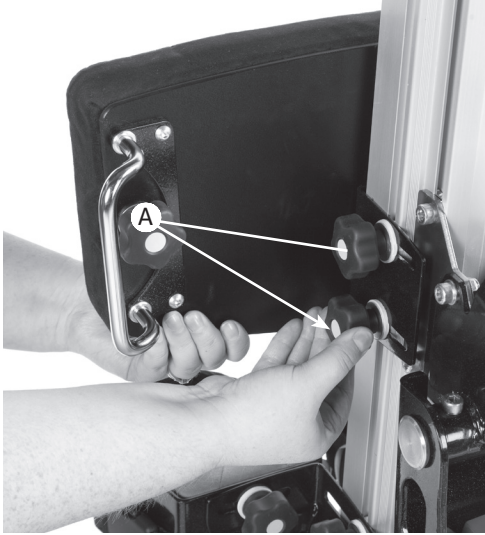

10.3 ADJUSTING THE KNEE SUPPORTS

The height and depth of the knee supports can be positioned independently by adjusting the mounting plate. To adjust the plate loosen the two knobs **A** and slide the plate and knee support to the required position and then retighten the knobs securely. Repeat the process for the other plate.

To alter the width of the knee supports and also if required, achieve some rotation, loosen the knobs **B**. and slide the pad to the required position and then retighten the knobs.

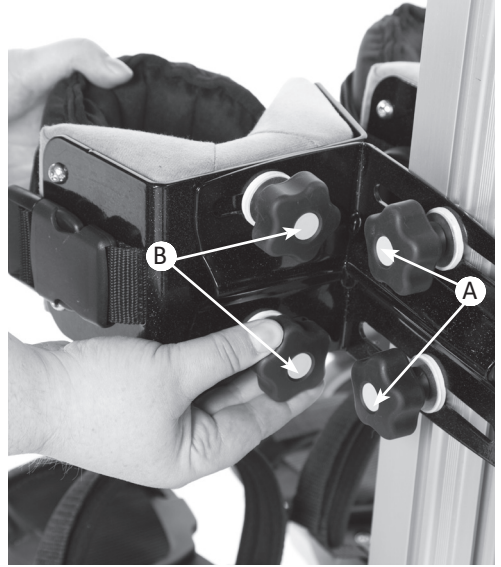

10.4 ADJUSTING THE STANDARD FOOTPLATES

The Leckey Horizon footplates are split to allow independent height and angle adjustment for exact positioning of both feet. To adjust the footplate height first loosen the allen bolts **A** and then slide the footplate to the required position and retighten securely. To alter the angle of the footplate to accommodate plantarflexion or dorsiflexion, simply rotate the coupling cylinder clockwise or anti clockwise respectively **B**.

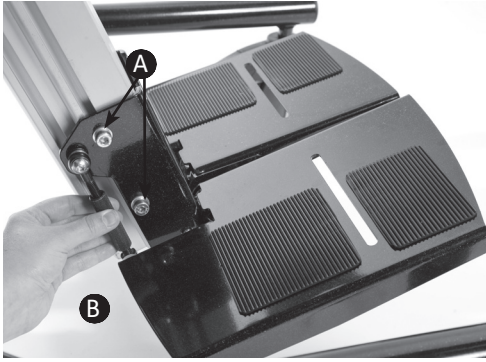

10.5 ADJUSTING THE FLIP-UP FOOTPLATES

The footplate is hinged at the front which allows the sandals to be adjusted more easily and can facilitate transfer from a seating position to prone standing. To avoid any possible finger nip issues lift the footplate at the notched area.



Use caution when lifting and lowering the footplate as fingers could become trapped.



10.6 ADJUSTING THE 3D FOOTPLATES

Loosen the three screws at the bottom of the ball and socket joint **A**. Swivel and adjust footplate to required position and tighten screws.

The footplate can also be adjusted to accommodate leg position by loosening screw **B** then you can slide left, right, backwards and forwards. To move footplate up and down, loosen the screw at the front of the footplate, slide into position and retighten **C**.

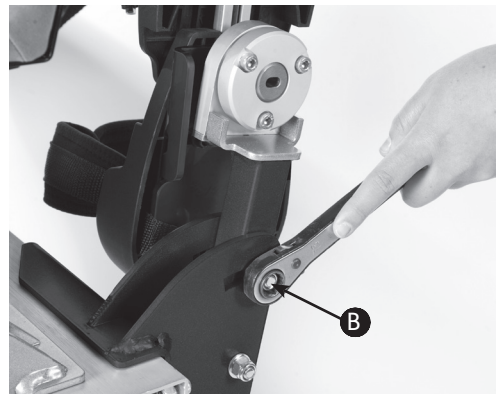

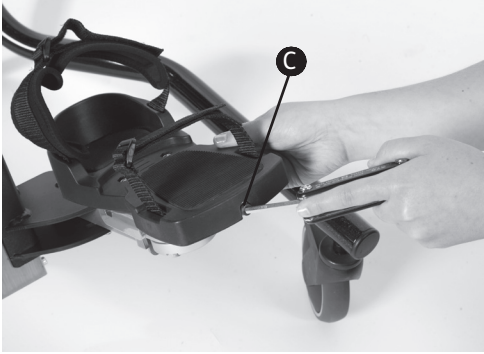

10.7 POSITIONING THE SANDALS

Each sandal is attached to the individual footplate with a single fixing bolt. The footplate is covered with a rubber pad to ensure the sandals do not slide when secured. If you wish to rotate the sandal laterally, simply loosen the knob, place in the required position and then re-tighten the knob securely **A**.

 Use caution when lifting and lowering the footplate as fingers could become trapped

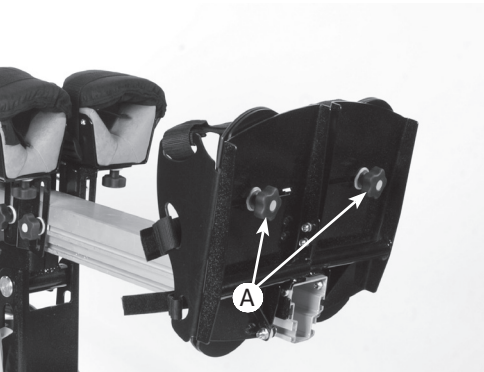

10.8 FLEXIBLE LATERAL SUPPORT ADJUSTMENT

The flexible lateral supports can be adjusted in height and width. To adjust the width, loosen the knob **B** on the back of the chest pad. Then adjust the lateral support to the required position and finally re-tighten the knob. To change the height, loosen as before, slide the bracket out fully and insert in an alternative slot **A**, replace the knob and tighten securely. As the lateral brackets are staggered in height, additional height range can be achieved by swapping the lateral from the left to the right side. The flexible lateral supports are secured around the user by tightening the safety strap **C** into position. Fasten the safety strap immediately.

 Check the laterals are secure before placing the user in the product. As if they are loose the user may be at risk of slipping into a position they cannot not recover from and could restrict their breathing.

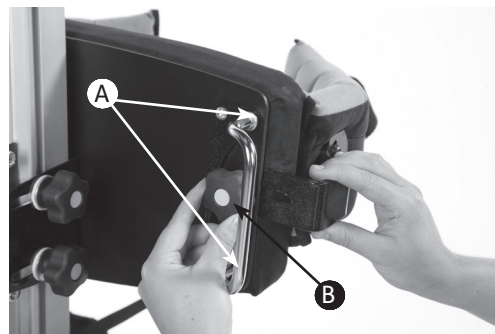



10.9 POSITIONING & ATTACHING THE PELVIC BAND

There is a different pelvic band for prone and supine standing. The pelvic band should be attached to the user first, if practical on a mat. The pelvic straps are attached around the user's pelvis and then when the user is secured into the frame (by their feet and chest) the longer straps are slipped through the belt bars **A** on the back of the hip pad and secured firmly around the user. The additional strap with the plastic buckle and clip **B** should be secured to ensure the straps are not accidentally unfastened. To ensure that you can easily identify the strap that goes around the user and the one that attaches to the hip pad, a Leckey label is sewn onto the one that attaches to the hip pad.

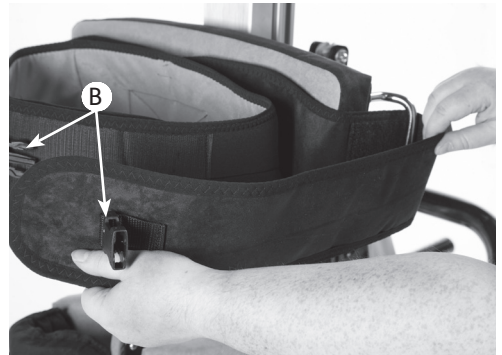

10.10 POSITIONING FLEXIBLE HIP LATERALS

The Flexible Laterals can be used as an alternative to the pelvic band. The Laterals can be individually adjusted in width as well as in height. To adjust the width loosen the knob **A** on the back of the hip pad, then adjust the flexible laterals to the required position and finally re-tighten the knobs.

For the height positioning of the Laterals loosen the allen bolt **B**, position the Lateral as required and then re-tighten the bolts securely. The flexible lateral



Always make sure the safety buckle is engaged so the Velcro straps are not accidentally undone which could allow the user to slide out of the product and cause serious injury.

supports are secured around the user by tightening the safety strap into position. Fasten the safety strap immediately.



Check the laterals are secure before placing the user in the product. As if they are loose the user may be at risk of slipping out of the product and could cause them serious injury.

To adjust the height loosen the four knobs **B** set the tray to the required position and then retighten the knobs securely.

The tray angle can be adjusted by loosening the plastic handle **C** on either side of the tray, set the tray to the required angle and tighten the plastic handles again securely.

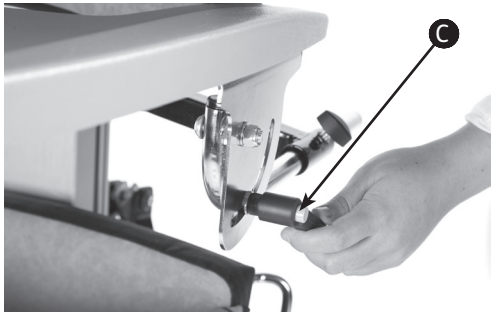
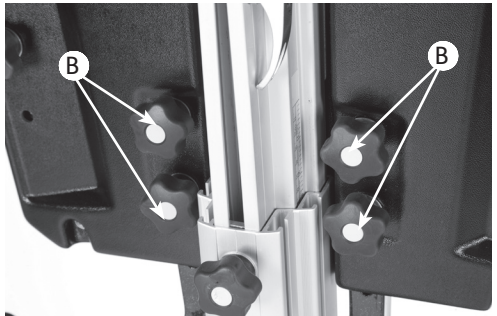
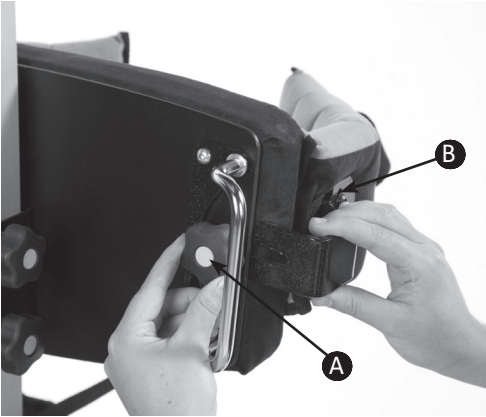

10.11 ACTIVITY TRAY ADJUSTMENT – SUPINE

The Tray is attached to and removed from the frame by the metal brackets located below the chest pad. To attach the tray, slide the metal bars into the receiving tubes to the required depth and secure by tightening the knobs **A** on either side. There are limit poppers in the end of the tray tubes to show the maximum depth adjustment allowed. These may need to be depressed to remove the tray.

10.12 ACTIVITY TRAY ADJUSTMENT – PRONE

To lock the tray and set its height, push the locking lever **A** down until it touches the metal spine. After use this may need to be fine tuned to ensure secure locking. To do this lift up the lever and turn the nut **B** while holding the lever in a fixed position. Push the lever back down to check if it locks the tube securely. Repeat the process as necessary.

The tray angle can be adjusted by loosening the ratchet handle on either side of the tray, set the tray to the required angle and tighten the plastic handles again securely.

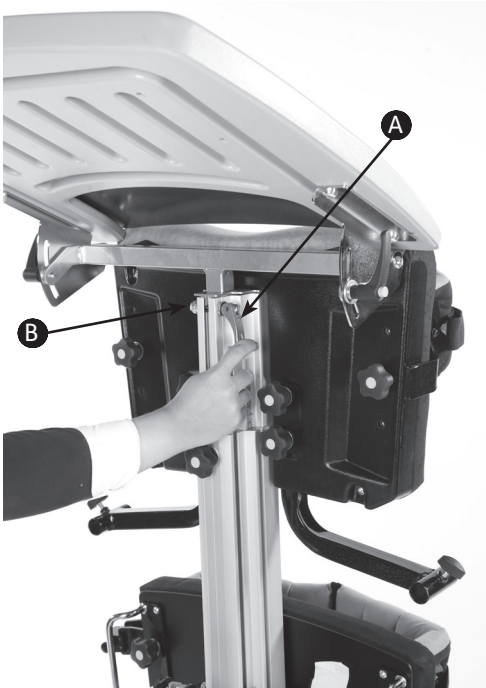

Always use caution when making this adjustment, as fingers could become trapped in the slot while positioning.

Always use caution when inserting the tray to make sure the child's hands or arms do not become trapped.

Do not place hot objects on the tray, not greater than 40 degrees Celsius.

Please note that the tray is for the use of the user only. Do not lean or place heavy objects on the tray, no greater than 8kgs (17.6lbs).

Never use the tray to steer or push the stander.

Do not height adjust the headsupport beyond the hazard strip at the end of the tube.

Always use caution when making this adjustment, as fingers could become trapped in the receiving tube while positioning.

The user may be at risk of slipping out of the product and could cause them serious injury.

10.13 HEAD SUPPORT ADJUSTMENT - SUPINE

The head support can be adjusted in depth, height and angle. To height adjust, unlock the lever **A** at the top of the central spine, position to the desired height and then re-lock.

For fine height, depth and angle adjustment loosen the two knobs **B**, one on either side of the square tube, position the head support and then re-tighten securely.

In addition to this, the contoured headrest can be adjusted laterally. Loosen the screw on top of the contoured headrest bar **C**. Adjust to the position required and retighten screw.

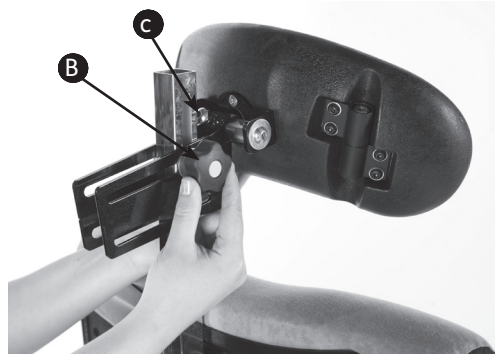

SECTION 11: PRODUCT CONVERSION

11.1 SUPINE TO PRONE

To convert the Leckey Horizon to the prone version, simply remove the head support and attach the prone tray. Remove the supine pelvic band and attach the prone version. Finally loosen the sandals and turn through 180 degrees and you are ready for prone standing.

Supine

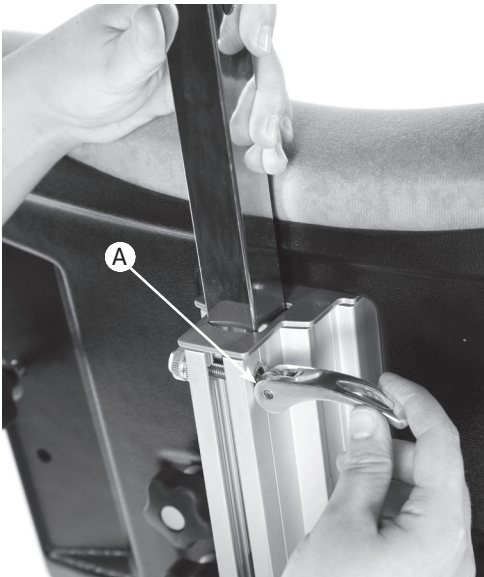

11.2 PRONE TO SUPINE

To convert the Leckey Horizon to the supine version, simply remove the prone tray. Attach the required head support as defined above. Remove the prone pelvic band and attach the supine version. Finally loosen the sandals and turn through 180 degrees and you are ready for supine standing.

SECTION 12: FREQUENT ADJUSTMENT FOR DAILY USE

Parents and carers should be shown how to make frequent adjustments and made aware of the safety checks in section 7 by a technically and clinically competent person who has been trained in the use of the product. Leckey recommend that a written record is maintained of all parent and carers who have been trained in the use of this product.

Prone



12.1 TRANSFERRING THE USER INTO AND OUT OF THE STANDER

Before transferring the child into the stander carry out the daily product inspection as outlined in section 14 of this user manual.

We would recommend that users are never transferred straight from seating to standing without preparation and stretching. This is best done in lying position whilst on a mat but can be carried out in a wheelchair or seating system if required.

Before transferring the child into the product lock all the castors, ensuring that they are facing outwards to maximise product stability. Make sure the straps on the flexible laterals supports, the pelvic band and sandals are released and out of the way to facilitate transfer.



Always secure the pelvic band or flexible hip pads first and then the flexible lateral supports.

12.2 CHARGING THE BATTERY

Before the product is used for the first time it is recommended to charge the battery **A** fully for at least 12 hours. To charge the battery, plug the adaptor into the mains socket, attach the lead to the frame and switch on the mains power. While charging the charger LED will remain orange and will turn to green when fully charged. When charged switch off mains power, remove the adaptor plug when and disconnect the lead from the frame. The battery charge should be topped up each day for approximately one hour.



If the battery is low in power an audible bleep will sound and 'battery low' will be indicated on the handset and control box **B**, indicating that it needs to be charged. Please note that there is a 'Stop' button **C** on the front of the control box for use in emergencies.

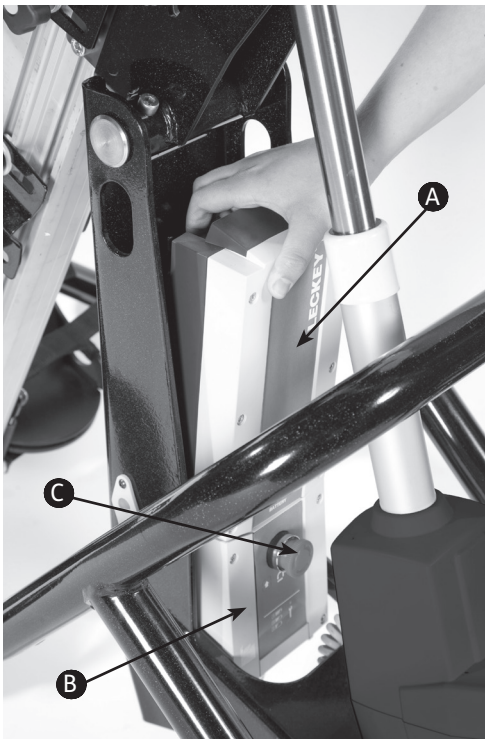

12.3 SETTING THE ANGLE

Whether used in supine or prone the frame angle can be easily adjusted with the push button control handset or the control box. There is also an angle adjustment sticker on the frame for guidance.



Ensure that the product and user are away from surrounding furnishings to prevent possible collisions when adjusting the angle.

Do not put your hands or fingers behind the knee supports while adjusting the angle of the product as they could become trapped.

12.4 FLEXIBLE LATERAL SUPPORTS

The flexible lateral supports are secured around the user by clipping the plastic buckle into its receiver. The safety strap **A** can then be tensioned if required.



Check the laterals are secure before placing the user in the product. As if they are loose the user may be at risk of slipping into a position they cannot not recover from and could restrict their breathing. prevent possible collisions when adjusting the angle.

Do not put your hands or fingers behind the knee supports while adjusting the angle of the product as they could become trapped.



12.5 FLEXIBLE HIP PADS

The flexible hip pads are secured around the user by clipping the plastic buckle into its receiver. The safety strap **B** can then be tensioned if required.



Check the hip pads are secure before placing the user in the product. As if they are loose the user may be at risk of slipping out of the product and could cause them serious injury.



12.6 THE FRONT KNEE SUPPORTS

The knee brackets come as standard with knee supports; these should always be used when the user is in supine, but can also be used for prone standing to give additional support and security. To fasten the pad, insert the plastic clip into the buckle on the side of the main knee support. Then grab the straps ends and pull firmly away from the user, which will secure the pad around the users leg. To remove the pad simply squeeze the tabs on the top and bottom of the plastic clip and the pad will pop off **C**.

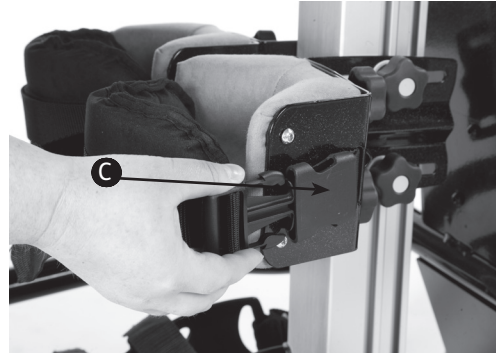



Always check with your therapist as to the correct tensioning of the straps for your child as the kneecap is a sensitive area and too much force could cause injury.

12.7 ACTIVITY TRAY ADJUSTMENT – SUPINE

The Tray is attached to and removed from the frame by the metal brackets located below the chest pad. To attach the tray, slide the metal bars into the receiving tubes to the required depth and secure by tightening the knobs **A** on either side. There are limit poppers in the end of the tray tubes to show the maximum depth adjustment allowed. These may need to be depressed to remove the tray.

To adjust the height loosen the four knobs **B**, set the tray to the required position and then retighten the knobs securely.

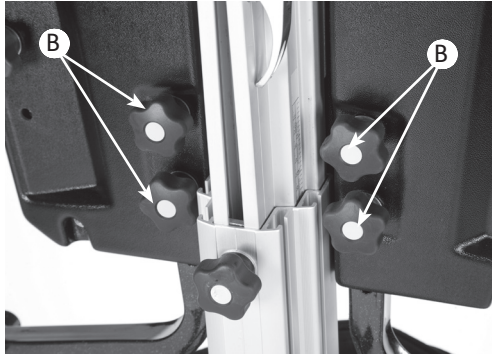

The tray angle can be adjusted by loosening the plastic handle **C** on either side of the tray, set the tray to the required angle and tighten the plastic handles again securely.

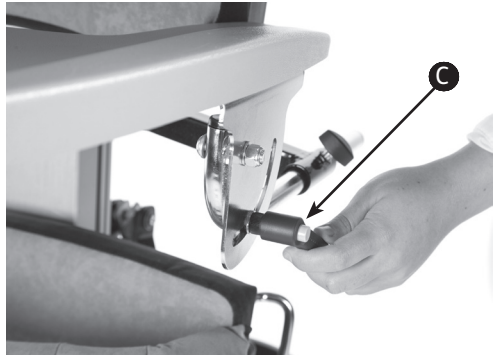

12.8 ACTIVITY TRAY ADJUSTMENT – PRONE

To lock the tray and set its height push the locking lever **A** down until it touches the metal spine. After use this may need to be fine tuned to ensure secure locking. To do this, lift up the lever and turn the nut **B** while holding the lever in a fixed position. Push the lever back down to

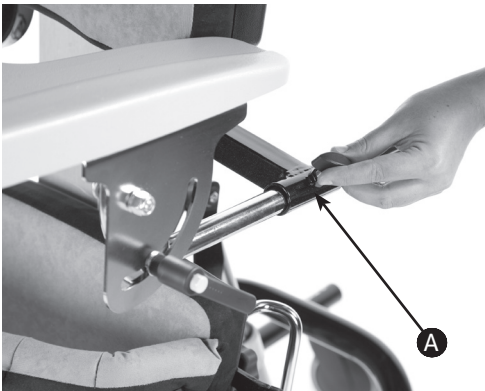

check if it locks the tube securely. Repeat the process as necessary.

The tray angle can be adjusted by loosening the ratchet handle on either side of the tray, set the tray to the required angle and tighten the plastic handles again securely.

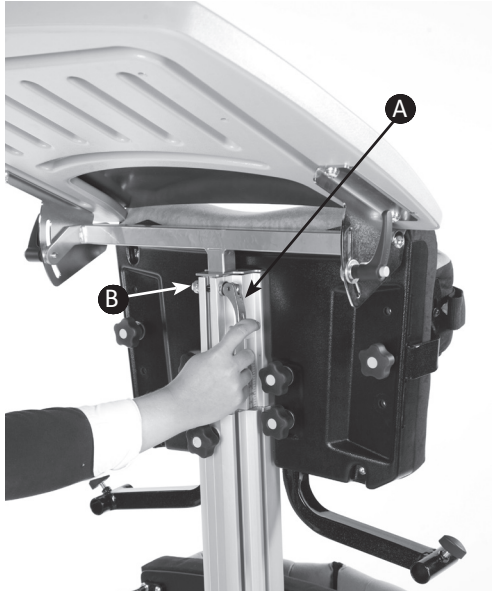

Always use caution when making this adjustment, as fingers could become trapped in the slot while positioning.

Always use caution when inserting the tray to make sure the child's hands or arms do not become trapped.

Do not place hot objects on the tray, not greater than 40 degrees Celsius.

Please note that the tray is for the use of the user only. Do not lean or place heavy objects on the tray, no greater than 8kgs (17.6lbs).

Never use the tray to steer or push the stander.

12.9 USING THE SANDALS

To position the user's feet in the sandals, secure the Velcro straps provided so the foot is held in place. The straps should be placed over the bridge of the foot and over the toes. The front strap can be fed through one of two slots on either side of the sandals, depending on the size of the user's feet **2**.



2

If the child is wearing sandals or light footwear check the straps to make sure the webbing does not irritate the skin.

SECTION 13: CLEANING & CARE INFORMATION

How to Maintain

1. It is advisable to charge the battery for at least one hour everyday. However if the powered actuator is not operating and you have checked that the handset is connected correctly you should stop using the product immediately and contact your local dealer.
2. At least once a week, check that all fixings and fastenings including the castors are in good condition.
3. The Leckey Horizon is manufactured from nylon coated metal, ABS plastic and plywood. When cleaning the frame we would recommend that you use warm water and a non-abrasive detergent.
4. When any parts of or accessories are not in use, we would advise that you store them together in a safe place for future use.
5. If you are in any doubt as to the safe use of your Leckey Horizon please cease from using the product and contact your local dealer as soon as possible.

Metal and plastic and wooden components

1. Soap and water or antibacterial spray can be used for daily cleaning.
2. The chassis should be cleaned with a damp cloth- do not use running water.
3. Do not use solvents to clean plastic wooden or metal components.
4. Make sure the product is dry before use.
5. Check all wooden components regularly to ensure there are no cracks or splitters.

Upholstery and fabrics

1. Clean and care for your fabric on a regular basis and it will maintain its condition and appearance.
2. Simply vacuum to remove dust particles and wipe with a damp cloth for general cleaning.
3. Microfibre cloths are extremely effective without soap, which is helpful as soap can clog your fabric.
4. Remove spillages promptly with an absorbent dry cloth such as above.
5. Take care not to cause abrasive damage.
6. For heavier soiling use a mild proprietary cleaner and warm water ensuring that cleaning products are fully removed.

7. Body fluids should be removed promptly with cold water and then cleaned as above.
8. Water and oil based stains may be removed by using most water based household proprietary spray cleaning agents, following instructions carefully.
9. For extreme soiling and infection control, use a 5% sodium hypochlorite (bleach) solution, using clean warm water to ensure excess products is removed.
10. Removable parts can be machine washed at 40° – Line drying is recommended.
11. Gentle Low Heat tumble dry is required.

SECTION 14: DAILY INSPECTION

Daily Product Inspection (Therapists, parents & carers)

We recommend that daily visual checks of the equipment are carried out by therapists, carers or parents to ensure the product is safe for use. The recommend daily checks are detailed below.

1. Ensure all adjustment knobs and bolts are in place and secure.
2. Check all upholstery for signs of wear and tear.
3. Check all castors are moving freely and lock securely.
4. Check all Velcro strips and brush fluff to ensure straps secure firmly.

SECTION 15: RE-ISSUING LECKEY PRODUCTS

Most Leckey products are assessed and ordered to meet the needs of an individual user. Before reissuing a product we recommend that the therapist prescribing the product has carried out an equipment compatibility check for the new user and has ensured that the product being re-issued contains no modifications or special attachments.

A detailed technical inspection should be carried on the product prior to re-issuing.

This should be carried out by a technically competent person who has been trained in the use and inspection of the product. Please refer to **section 14** for the required checks to be carried out.



If in any doubt to the continued safe use of your Leckey product or if any parts should fail, please cease using the product and contact our customer service department or your local dealer as soon as possible.

Before re-issuing a product, we recommend it is disinfected using the following procedure:

Note: Always clean the product first to remove accumulated soiling prior to disinfecting/sanitising

1. Where possible, we recommend the use of an automated “fogger” disinfection system that is used to completely cover the product surfaces with a disinfectant agent. The manufacturer’s instructions for the chosen system should be referred to prior to use and followed exactly.
2. Where an automated disinfection system is not available, all product surfaces should be wiped over with disinfectant surface wipes or liquid disinfectant on a soft cloth. Suitable products are 70% IPA, 70% Alcohol or diluted bleach. The manufacturer’s instructions for the chosen product should be followed. Product upholstery and fabrics should be cleaned thoroughly in accordance with section, Cleaning and Care Information, of this manual.











Ensure a copy of the user manual is supplied with the product. A copy can be downloaded from our website www.leckey.com









Leckey recommend that a written record is maintained of all product inspections carried out during the reissue of the product.

SECTION 16: TECHNICAL DATA

Product	Size 1		Size 2		Size 3	
Length	1135	44.7	1280	50.4	1280	50.4
Width (without tray)	580	22.8	640	25.2	640	25.2
Height in Horizontal Position	780	30.7	805	31.7	805	31.7
Weight of Product	44kg	97lbs	50kg	110.6Lbs	59kg	130lbs
Max User Weight	50kg	110Lbs	80kg	176Lbs	100kg	220lbs
User Standing Height						
min	1000	39.4	1400	55.1	1550	61
max	1400	55.1	1800	70.9	1800	70.9
Shoulder Height (footplate to top of pad)						
min	820	32.3	1000	39.4	1000	39.4
max	1150	45.3	1450	57	1450	57
Hip Pad Height (footplate to top of pad)						
min	450	17.7	750	29.5	750	29.5
max	750	29.5	950	37.4	1150	45.3
Hip Pad Width						
min	175	6.9	210	8.3	8.3	12.2
max	270	10.6	390	15.3	470	
Knee Height (footplate to middle of pad)						
min	250	9.8	400	15.7	400	15.7
max	450	17.7	550	21.6	650	25.6
Width Between Chest Laterals						
min	200	7.9	240	9.4	340	13.4
min	300	11.8	380	14.9	460	18.1
Footplate Angle Adjustment						
+/-	10°	10°	10°	10°	10°	10°
Tray Sizes	420	16.5	520	20.5	520	20.5
	x 440	x 17.3	x 590	x 23.2	x 590	x 23.2
Tray Angle Adjustment Prone Version	0° to	0° to	0° to	0° to	0° to	0° to
	40°	40°	40°	40°	40°	40°
Tray Angle Adjustment Supine Version	20°/30°	20°/30°	20°/30°	20°/30°	20°/30°	20°/30°
Frame Clearance (bottom of ski to ground)	155	6.1	180	7	180	7

TABLE OF SYMBOLS

Symbol	Meaning
	Medical Device
	Read the Instructions for Use
	CE mark
	UKCA mark
	Warning
	Do not dispose in domestic waste
	Manufacturer
	Serial number
	Product code
	Max occupancy weight

Symbol	Meaning
	Date of Manufacture
	For indoor use only
	Latex free
	Unique Device Identification
	Machine wash- water temperature 40°C
	Machine wash- water temperature 70°C
	Tumble dry- low heat
	Do not iron
	Do not bleach

SECTION 17: CUSTOMER – JAMES LECKEY DESIGN LIMITED SPECIFICATIONS FOR LINAK PRODUCTS SUPPLIED

LINAK Actuator

343200-0020004X
Rated IP54
Duty Cycle: 2/18 – 2 minutes continuous use followed by 18 min not in use.
Ambient temperature +5° to +40° C
Push Max 10,000N
Pull Max 6000N
Self Lock at 10,000N Push, 6000N Pull
Typical speed with full load 5mm/sec
Max amps at load of 6000N is 7 amps
Noise level below 50 dB (A)
Power input voltage 24v +- 10%

LINAK Control Box

CBJC0033-01
Rated IP: IP54
Duty Cycle Max 10% or 6 minutes per hour followed by 18 min not in use.
Ambient temperature +5° to +40° C
Rated Capacity 2.9 Ah 24v
Lead acid gel filled battery

LINAK Handset

HD8X052-00
Rated IP54
Control current 100mA per channel (Max)
Ambient temperature +5° to +40° C

LINAK Battery Charger - CH01

Mains 100-240 VAC/50-60 Hz switch mode power supply
Charging voltage 27.6 VDA +- 2%
Charging current Max 500mA
Green LED for power on
Yellow LED for charging function
Yellow LED turns into green when batteries are fully charged.

Linak products may be stored in non-heated storage facilities with humidity between 0 and 100%, none condensing.

None condensing means that one should not take a product an ice cold warehouse into a room with a temperature of 20deg C; if this is done then moistness will appear on the products.



USA Distributor

Sunrise Medical (US) LLC
2842 N Business Park Avenue
Fresno, CA 93727

T: 1-800-333-4000
F: 1-800-300-7502
E: customseating@sunmed.com

sunrisemedical.com

Canadian Distributor

Sunrise Medical
237 Romina Drive, Unit 3,
Concord, ON, L4K 4V3

T: +1.800.263.3390
F: +1.800.561.5834
E: mkt.canada@sunmed.com

sunrisemedical.ca

Please visit leckey.com for a full list of Leckey distributors.

**UK
CA**

James Leckey Design Limited
19 Ballinderry Road
Lisburn, BT28 2SA
Northern Ireland

leckey.com

[+44] 28 9260 0750
hello@leckey.com

